



# RedCos-P pressure sensor from 20 Pa...7.500 Pa

Electrical, explosion proof pressure or differential pressure sensor  
24 VAC/DC supply voltage, 0...10 V / (0)4...20 mA analogue output  
PTB-certified in acc. with ATEX directive 94/9/EC for zone 2, 22.

RedCos - P...  
RedCos - P... - A  
RedCos - P... - CT  
RedCos - P... - OCT

Subject to change!

**Compact . Easy installation . Universal . Cost effective . Safe**

Type	Sensor	Supply	Range	min. Range	max. Pressure	Output	Ex-i output	Wiring
RedCos - P100	Pressure-/Diff. press.	24 VAC/DC	+/- 100 Pa	20 Pa	25.000 Pa	(0) 4 .. 20 mA / 0 .. 10 V	-	SB 1.0
RedCos - P250	Pressure-/Diff. press.	24 VAC/DC	+/- 250 Pa	50 Pa	25.000 Pa	(0) 4 .. 20 mA / 0 .. 10 V	-	SB 1.0
RedCos - P500	Pressure-/Diff. press.	24 VAC/DC	+/- 500 Pa	100 Pa	50.000 Pa	(0) 4 .. 20 mA / 0 .. 10 V	-	SB 1.0
RedCos - P1250	Pressure-/Diff. press.	24 VAC/DC	+/- 1.250 Pa	250 Pa	50.000 Pa	(0) 4 .. 20 mA / 0 .. 10 V	-	SB 1.0
RedCos - P2500	Pressure-/Diff. press.	24 VAC/DC	+/- 2.500 Pa	500 Pa	50.000 Pa	(0) 4 .. 20 mA / 0 .. 10 V	-	SB 1.0
RedCos - P5000	Pressure-/Diff. press.	24 VAC/DC	+/- 5.000 Pa	1.000 Pa	75.000 Pa	(0) 4 .. 20 mA / 0 .. 10 V	-	SB 1.0
RedCos - P7500	Pressure-/Diff. press.	24 VAC/DC	+/- 7.500 Pa	1.500 Pa	120.000 Pa	(0) 4 .. 20 mA / 0 .. 10 V	-	SB 1.0
RedCos - P.. - A	as above, but with additional intrinsically safe analogue output to connect an external digital indicator						(0) 4 .. 20 mA (Ex-i)	SB 3.0
RedCos - P.. - CT	as above, with Al housing and amercoat painting (sensor connection and cable glands nickel-plated, screws in stainless steel)							
RedCos - P.. - OCT	as above, offshore version seawater resistant, with Al housing and amercoat painting (stainless steel tubes for clamping ring connection, cable glands M20 x 1,5 nickel-plated, screws in stainless steel)							

## Application

Pressure/diff. pressure sensor

ExCos-..CT (Amercoat version)

ExCos-..OCT (Offshore version)

Accessory: external indicator Ex-i



## Description

The RedCos-P.. pressure sensor generation from  $\pm 100$  Pa to  $\pm 7.500$  Pa (acc. to type) is a revolution for differential pressure measuring in HVAC systems, in chemical, pharmaceutical, industrial and Offshore-/Onshore plants, for use in hazardous areas zone 2 (gas) and zone 22 (dust).

Highest protection class (ATEX) and IP 66 protection, small dimension, universal functions and technical data guarantee safe operation even under difficult environmental conditions.

The measuring ranges are scalable within the maximum ranges. At RedCos-P100 the smallest  $\Delta P$  range is 20 Pa. The analogue output signal is either 0...10 VDC or 4...20 mA and can be selected on site. The integrated display is for actual value indication which can be switched off. All sensors are programmable on site without any additional tools.

RedCos-P..-A sensors are additionally equipped with a 4...20 mA IS (IS = intrinsically safe) output, e.g. for an external indicator.

RedCos-P..-OCT is equipped with stainless steel 316L tubing  $\varnothing 6$  mm.

## Highlights

- ▶ For all type of gas, mixtures, vapours and dust for use in zone 2 and 22
- ▶ Integrated junction box
- ▶ Power supply 24 VAC/DC
- ▶ Display with backlight, can be switched off
- ▶ Scalable analogue output, selectable 0...10 V / (0) 4...20 mA
- ▶ Compact design and small dimension (L x W x H = 177 x 107 x 66 mm)
- ▶ Robust aluminium housing in protection class IP 66
- ▶ Down to -20°C ambient temperature applicable
- ▶ Password locking
- ▶ Optional IS-output (4 .. 20 mA) for external indicator in Ex-areas
- ▶ CT versions have an excellent resistance to chemicals and sea water.
- ▶ OCT as CT version plus pressure tube connection for clamping ring  $\varnothing 6$  mm



Technical data	RedCos - P...
Power supply	24 VAC/DC +/- 20% (19,2 ... 28,8 VAC/DC) 50...60 Hz
Current, power consumption	150 mA, ~ 4 W, internal fuse 500 mA, without bracket, not removable
Galvanic isolation	supply – analogue output 1,5 kV (Ex 60 V)
Electrical connection	terminals 0,14 ... 2,5 mm <sup>2</sup> at integrated junction box
Cable entry	2 × M16 × 1,5 cable diameter ~ Ø 5...10 mm (..CT in nickel-plated)
Cable entry OCT	2 × M20 × 1,5 Ex-e approved, cable diameter ~ Ø 6...13 mm (..OCT in nickel-plated)
Protection class	Class I (grounded)
Display	2 × 16 digits, dot-matrix with backlight, display for configuration, user guidance, parameter and actual value indication
Control elements	3 buttons for configuration
Housing protection	IP66 in acc. to IEC 60529
Housing material	aluminium casting, coated (..-CT/..-OCT = version in amercoat, marine painting, seawater-resistant ..-OCT = Offshore version)
Dimension / weight	L × W × H = 177 × 107 × 66 mm / ~ 950 g
Ambient temperature/-humidity	-20...+50 °C / 0 ... 95 %rH, non condensed
Storage temperature	-40...+70°C
Measuring range	± 100 Pa, ± 250 Pa, ± 500 Pa, ± 1.250 Pa, ± 2.500 Pa, ± 5.000 Pa, ± 7.500 Pa in acc. to type
Range scalable on site	minimum measuring range is 10% of full range (e.g. 20 Pa @ ± 100 Pa sensor)
Maintenance	maintenance free, nevertheless maintenance must be complied with regional standards, rules and regulations
Sensor circuit	internal IS circuit
Sensor	Piezo-pressure-transmitter
Pressure connection	P+ / P- sleeves Ø 4...6 mm, OCT-version has a Ø 6 mm stainless steel tube connection for clamp ring fittings.
Response time of sensor	T90 / 5 sec.
Accuracy of pressure	± 2 % of end value ± 1 Pa
Non linearity and hysteresis	± 0,05 % typically, max. 0,25 % of end value
Start delay	5 sec.
Setting zero point	via menu, mechanical short circuit of P+ / P- for the moment of zero point setting
Stability	long term stability < 0,2 %/year, temperature influence < 0,02 %/K, supply voltage influence < 0,01 %
Output	voltage U(V) or current I(mA) selectable via menu on site
Output protection	against short circuit and external voltage up to 24 V, protected against polarity reversal
Voltage output U	from 0...10 VDC adjustable, invertible, burden > 1 kΩ, influence < 0,05% / 100 Ω
Current output I	from 0...20 mA adjustable, invertible, burden < 500 Ω, influence < 0,1% / 100 Ω, open circuit voltage < 24 V
Output at alarm mode	increasing or decreasing output signal, selectable on site, down to 0 VDC/0 mA or up to 10 VDC/20 mA
Wiring diagram (SB)	SB 1.0
Delivery (changeable on site)	min./max. pressure range limits (e.g. RedCos-P100 = -100...100 Pa), output 4...20 mA, output with decreasing alarm situation to 0V/0mA
Included in delivery	<b>RedCos-P...</b> with 3 screws 4,2 × 13 self-tapping and short circuit tube, ~ 140 mm length (by <b>ExCos-P..-OCT</b> ~ 250 mm length)
Installation sensor / tubing	in Ex-area zone 2, 22
<b>Additional information for RedCos-P...-A:</b>	
Analogue output	(0) 4...20 mA
Ex-i	Intrinsically Safe (IS)
Burden	max. 400 Ω
Accuracy	± 0,5 %
Plug	cable diameter Ø 6...8 mm
Delivery version ...-P-A	incl. 1 × plug

Explosion proof	RedCos-P...
PTB-testet	PTB 08 ATEX 2003
acc. to ATEX directive	RL 94/9/EC (ATEX)
Approval for gas	II3(1)G Ex nC [ia] IIC T6 for zone 2
Approval for dust	II3(1)D Ex tD A22 [iaD] IP66 T80°C for zone 22
Identification	CE Nr. 0158
EMC	89/336/EC EMC directive
Low voltage	73/23/EC low voltage directive
Protection type	IP 66 in acc. to EN 60529
Potential compensation	external PA-terminal, 4 mm <sup>2</sup>

Accessories	
<b>EXC-RIA-261</b>	LCD indicator (IS), installation in Ex-areas zones 1, 2, 21, 22, connectable direct to RedCos... sensores with type RedCos-P.- A
<b>MKR</b>	Mounting bracket for round ducts up to Ø 600 mm
<b>Kit 2</b>	consists of 2 m flexible pressure tube Ø 6 mm, 2 connection nipples

**Electrical connection**

RedCos-P... sensors required a 24 VAC/DC power supply. The supply has to be connected at terminal 1 (-/-) and 2 (+/-), the analogue output at terminal 3 (mA/V) and 4 (GND). The electrical wiring must be realized via integrated junction box.

**Attention!** Before opening the junction box cover, the supply voltage must be shut off! The optional analogue output at RedCos-P...-A is intrinsically safe. Note the maximum connection values of intrinsically safe parameters (see table below).

**Wiring Diagram RedCos-P...**

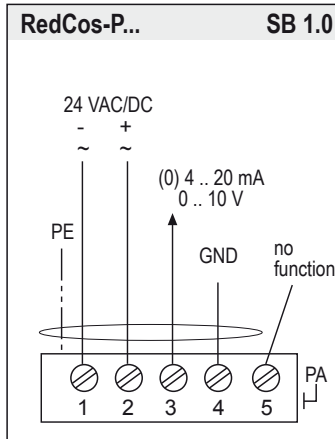

**Zero point compensation for pressure transmitter**

RedCos-P... pressure sensor is equipped with a zero point compensation, to adjust the module to the installation position. The pressure nipples P+ / P- must be connected with a short circuit tube. To make compensation please follow the menu. In menu point 18 zero point compensation is done by push button. Before starting the zero point compensation, the device should be connected to the power supply for minimum of 15 minutes, to reach the working temperature!

**Display and Buttons**

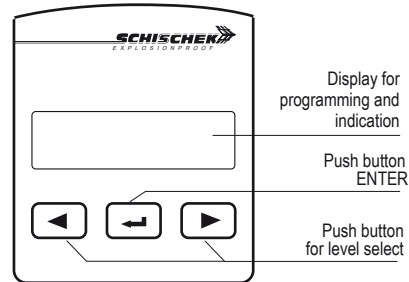

**Change operation- / parametrisation mode**

To change from operation to parametrisation mode and vice versa, push the enter button for minimum 3 seconds.

**Indication of data logging**

A blinking star in the display shows that datas received and the device is working.

**Wiring Ex-i (IS) output (optional) at RedCos-P...A**

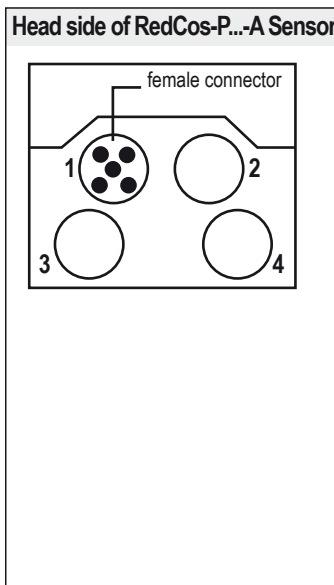
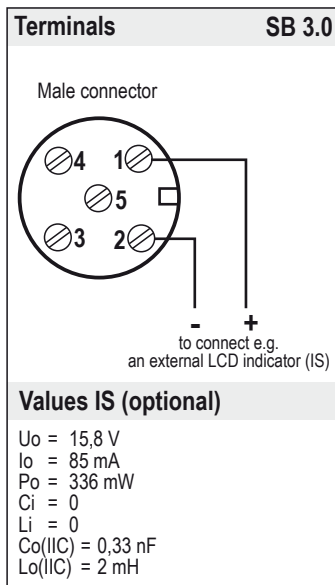

**Password input**

The default / delivery setup is 0000. In this configuration the password input is not activated. To activate a password, go to menu point 20, change the 4 digits into your choosen numbers (e.g. 1234) and press Enter.

**Please keep your password in mind for next parameter change!**

Due to a new parameter setup the password is requested.

**Important information for installation and operation**

**A. Installation, Commisioning, Maintenance**

The cable has to be drawn through the cable gland. After electrical connection the cable gland must be fixed tight. IP66 must be fulfilled.

In acc. with operation RedCos sensors are maintenance free. Nevertheless maintenance must comply with regional standards, rules and regulations.

The sensors must not be opened by the customer. For outdoor installation a protective housing against rain, snow and sun should be applied. For electrical connection use the internal junction box.

**Attention:** Note the explosion proof rules before opening the internal junction box. Cut off the power supply.

**B. Pressure sensors**

After mounting and installation, a zero point compensation must be done, because the offset value depends on the installation position. Have a look to parametrisation.

**C. Long cabling**

For using long signal wires, shielded cables are recommended. The shield must be connected to the RedCos-P sensor inside the terminal box.

**D. Separate ground wires**

Use for supply and signal wires a separate ground.

**Dimensions / Drillings**

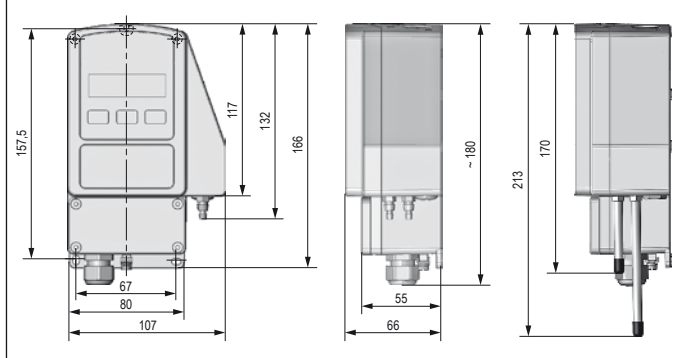

**Values intrinsically safe (IS) pressure sensor**

**Internal sensor values**

U<sub>o</sub> = 7,9 V  
I<sub>o</sub> = 48 mA  
P<sub>o</sub> = 95 mW  
C<sub>i</sub> = 0  
L<sub>i</sub> = 0

Internal sensor IS values are corresponding to the internal pressure sensor. Due to the matter of fact that there is no external sensor connected, these IS values are not relevant for the customer but shown for the sale of completeness.

C<sub>o</sub> (IIC) = 1,3 nF  
L<sub>o</sub> (IIC) = 2 mH

**Parametrisation and commissioning of RedCos-P(-A) transducers**

**Preparation of parametrisation/operation**

Operation ↔ Parametrisation, push  for 3 sec.

If password (PW) protection is active: put PW in, push 















































































**Change operation- / parametrisation mode**

To change from operation to parametrisation mode push „enter button“  for minimum 3 seconds. Back over the menu save and exit.

**Example**

**Menu language** english  
**Range** -25...+25 Pa  
**Output** 4...20 mA  
**Output Ex-i** 4...20 mA

Menu	Function	Enter	Indication	Select	Enter	Next indication	Next selection	Enter	Next menu
Menu 1	DE, EN, FR select language: german, english, french		DE, EN, FR english deutsch, english, francais	 					
Menu 2	no function - menu skip								
Menu 3	no function - menu skip								
Menu 4	unit sensor select physical unit		unit sensor Pa Pa, mbar, inH2O	 					
Menu 5	range adjust the measuring range		range -25...100 Pa ↑ adjust lower limit	 		range -25...25 Pa ↑ adjust higher limit	 		
Menu 6	no function - menu skip								
Menu 7	output V, mA select output signal as VDC or mA		output V mA mA mA / V	 					
Menu 8	output range adjust the output range		output range 4...20mA ↑ adjust lower limit	 		output range 4...20mA ↑ adjust higher limit	 		
Menu 9	sensor error select signal at sensor error		sensor error 10V / 20 mA 10V / 20 mA oder 0V / 0mA	 					
Menu 10	output   select if signal output is increasing or decreasing		output   increasing   increasing, decreasing	 					
Menu 11	no function - menu skip								
Menu 12	no function - menu skip								
Menu 13	no function - menu skip								
Menu 14	no function - menu skip								
Menu 15	no function - menu skip								
Menu 16	output Ex (option, only at RedCos-P-A) adjust 4...20 mA or 0...20 mA IS output signal		output Ex-i 4...20 mA ↑ adjust lower limit	 		output Ex-i 4...20 mA ↑ adjust higher limit	 		
Menu 17	no function - menu skip								
Menu 18	zero point compensation after short circuit the pressure nipples P+ / P- the sensor gets a zero point calibration.		set zero point yes no	 					
Menu 19	display function select display on/off, illuminated or backlight off		display function on illuminated on/illuminated, on, off	 					
Menu 20	password select password protection		new password yes no	 		password 0000	 		
Menu 21	save and exit select save data / factory setting / discard or back to menu		save and exit save data	 					
Menu 22	Set offset Add / subtract from measures value		set offset 0.00Pa	 					
Menu 23	no function - menu skip								