

InMax ¼ turn actuators – size S

Electrical rotary actuators for use in safe areas

3-pos. / 0...10 VDC / 4...20 mA control mode, with feedback, 24...240 VAC/DC, 95° angle of rotation

5/10 Nm, 15/30 Nm without and 5/10 Nm, 15 Nm with safety operation (spring return)

InMax - ... - Y
InMax - ... - YF
InMax - ... - CTS
InMax - ... - VAS

Subject to change!

Compact. Easy installation. Universal. Cost effective. Safe.

Type	Torque	Supply	Motor running time	Spring return	Control mode	Feedback	Wiring diagram
InMax- 5.10 - Y	5 / 10 Nm	24...240 V AC/DC	7,5 / 15 / 30 / 60 / 120 s/90°	–	3-pos., 0...10 V DC, 4...20 mA	0...10 V DC, 4...20 mA	SB 5.0 – 5.3
InMax-15.30 - Y	15 / 30 Nm	24...240 V AC/DC	7,5 / 15 / 30 / 60 / 120 s/90°	–	3-pos., 0...10 V DC, 4...20 mA	0...10 V DC, 4...20 mA	SB 5.0 – 5.3
InMax- 5.10 - YF	5 / 10 Nm	24...240 V AC/DC	7,5 / 15 / 30 / 60 / 120 s/90°	3 or 10 s/90°	3-pos., 0...10 V DC, 4...20 mA	0...10 V DC, 4...20 mA	SB 5.0 – 5.3
InMax- 15 - YF	15 Nm	24...240 V AC/DC	7,5 / 15 / 30 / 60 / 120 s/90°	3 or 10 s/90°	3-pos., 0...10 V DC, 4...20 mA	0...10 V DC, 4...20 mA	SB 5.0 – 5.3
InMax- ... - CTS	Types as above with aluminium housing and seawater resistant coating (cable glands brass nickel-plated)						
InMax- ... - VAS	Types as above with stainless steel housing for aggressive ambient (cable glands brass nickel-plated)						

Product views and applications

Safety damper



Ball valve



Throttle valve

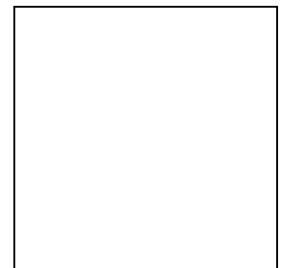

Description

The InMax actuators are a revolution for safety, control and shut-off dampers, VAV systems, ball valves, throttle valves and other motorized applications for HVAC systems in chemical, pharmaceutical, industrial and offshore/onshore plants.

IP66 protection, small dimensions, only 3,5 kg weight, universal functions and technical data, an integrated heater and an optional stainless steel housing guarantee safe operation even under difficult environmental conditions. High quality brushless motors guarantee long life.

All actuators are programmable and adjustable on site. Special tools or equipment are not required. Motor running times and torques as well as spring return times, according to the actuator type, are selectable or adjustable on site. The integrated universal power supply is self adaptable to input voltages in the range of 24...240 VAC/DC. Furthermore it is possible to perform control signal inverting and compulsion control by certain connections. The actuators are 100 % overload protected and self locking.

...Max-...-YF actuators are equipped with spring return fail safe function. Standard shaft connection is a double square direct coupling with 12 x 12 mm.

Different accessories are available to adapt auxiliary switches, terminal boxes or adaptions for ball valves and throttle valves and other armatures.

Highlights

- ▶ Industrial use
- ▶ Universal supply unit from 24...240 VAC/DC
- ▶ 5 different motor running times 7,5–15–30–60–120 s/90°, adjustable on site
- ▶ 2 different spring return running times ~ 3–10 s/90°, selectable on site
- ▶ 3-pos. and 0...10 VDC, 4...20 mA control mode with or without spring return function
- ▶ Feedback signals 0...10 VDC and 4...20 mA
- ▶ Reverse function
- ▶ 5–10–15–30 Nm actuators in the same housing size
- ▶ 100 % overload protected and self locking
- ▶ Compact design and small dimension (L x W x H = 210 x 95 x 80 mm)
- ▶ Direct coupling to the damper shaft with double square connection 12 x 12 mm
- ▶ 95° angle of rotation inclusive 5° pretension
- ▶ Robust aluminium housing (optional with seawater resistant coating) or in stainless steel
- ▶ IP66 protection
- ▶ Simple manual override included + preparation for comfortable manual override
- ▶ Gear made of stainless steel and sinter metal
- ▶ Weight only ~ 3,5 kg
- ▶ Integrated heater for ambient temperatures down to -40 °C
- ▶ Integrated safety temperature sensor
- ▶ Integrated equipment for manual adjustment (push button, lamp, switch)
- ▶ Preparation for adaptable and adjustable auxiliary switches type ...Switch

Technical data	InMax- 5.10 -Y	InMax- 15.30 -Y	InMax- 5.10 -YF	InMax- 15 -YF
Torque motor (min.)	5 / 10 Nm selectable on site	15 / 30 Nm selectable on site	5 / 10 Nm selectable on site	15 Nm
Torque spring (F)	–	–	min. 10 Nm	min. 15 Nm
Torque blockade	In blockade and end positions torques are higher than above specified torques for motor and spring.			
Dimensioning of external load	Upon spring return the external load should be max. 80 % of torque spring (F), but min. 3 Nm			
Supply voltage / frequency	24...240 VAC/DC \pm 10 %, self adaptable, frequency 50...60 Hz \pm 20 %			
Power consumption	max. starting currents see ⓘ Extra information (in acc. with voltage, $I_{start} \gg I_{rated}$), approx. 5 W holding power, approx. 16 W for heater			
Protection class	Class I (grounded)			
Angle of rotation and indication	95° incl. \sim 5° pretension, mechanical value indication			
Working direction	Selectable by left/right mounting to the damper/valve shaft			
Motor running times	7,5 / 15 / 30 / 60 / 120 s/90° selectable on site			
Motor	Brushless DC motor			
Control mode Y	3-pos., 0...10 VDC, 4...20 mA in acc. with wiring, selectable on site. Galvanic separation between supply and Y-signal			
Feedback signal U	0...10 VDC, 4...20 mA in acc. with wiring, selectable on site, both signals are available at the same time			
Resistance of Y and U signals	Input signal: U_U 0...10 VDC at 10 k Ω , Y_1 4...20 mA at 100 Ω . Feedback signal: U_U 0...10 VDC at 2.000... ∞ Ω , U_1 4...20 mA at 0...800 Ω			
Reverse function	Bridge between wiring 3 and 4 (signal wise) gets a reverse function of Y and U			
Compulsion control	In modulation mode an On-off compulsion control can be performed by external connection /wiring independently from the modulating signal			
Adjustment of Y and U	In case of external mechanical limitation of the angle of rotation, it is possible to perform an adjustment drive started by pushing the button (T)			
Spring return (F)	–	–	spring return upon voltage interruption	
Spring return response time	–	–	up to 1 sec. after voltage interruption	
Spring return running time (F)	–	–	\sim 3 or 10 s/90° selectable on site	
3 sec. mode – spring return	–	–	\sim 3 to 4 s/90° angle of rotation acc. to external load	
Safety operations at 10 sec. (F)	–	–	min. 10,000 acc. to construction of damper and ambient	
at 3 sec. (F)	–	–	min. 1,000 acc. to construction of damper and ambient	
Axle of the actuator	Double square 12 \times 12 mm, direct coupling, 100 % overload protected and self locking up to 15 Nm			
Electrical connection	2 cables \sim 1 m each, wire cross section 0.5 mm ² , equipotential bonding 4 mm ² . Connections require a terminal box!			
Diameter of cable	\sim \varnothing 7.1 + 7.4 mm	\sim \varnothing 7.1 + 7.4 mm	\sim \varnothing 7.4 mm each	\sim \varnothing 7.4 mm each
Cable gland	M16 \times 1.5 mm			
Manual override	Use delivered socket wrench, max. 4 Nm			
Heater	Integrated, controlled heater for ambient temperature down to -40 °C			
Housing material	Aluminium die-cast housing, coated. Optional with seawater resistant coating (...-CTS) or stainless steel housing, № 1.4581 / UNS-J92900 / similar AISI 316Nb (...-VAS)			
Dimensions (L \times W \times H)	210 \times 95 \times 80 mm, for diagrams see ⓘ Extra information			
Weight	\sim 3,5 kg aluminium housing, stainless steel \sim 7 kg			
Ambients	Storage temperature -40 ... $+70$ °C, working temperature -40 ... $+50$ °C			
Humidity	0...90 % rH, non condensing			
Operating 7,5 sec. motor run time	at 24 V: S3 – 50 % ED intermittent mode (ED = duty cycle)			
\geq 15 sec. motor run time	at 15 / 30 / 60 / 120 s 100 % of ED is permitted			
Accuracy electrically	\sim 100 steps			
Self adjustment	Before initial operation you need to start the self adjustment mode for „gentle blockade“ and adjustment of rotation angle			
Wiring diagrams	SB 5.0 / 5.1 / 5.2 / 5.3			
Scope of delivery	Actuator, 4 screws M4 \times 100 mm, 4 nuts M4, Allen key for simple manual override			
Parameter at delivery	5 Nm, 30 s/90°	15 Nm, 30 s/90°	5 Nm, 30 s/90°	15 Nm, 30 s/90°

Approbations

CE identification	CE
EMC directive	2014/30/EU
Low voltage directive	2014/35/EU
Enclosure protection	IP66 in acc. with EN 60529

Special solutions and accessories

...-CTS	Types in aluminium housing with seawater resistant coating, parts nickel-plated
...-VAS	Types in stainless steel housing, parts nickel-plated
InBox-Y/S...	Terminal boxes
MKK-S	Mounting bracket for boxes type ...Box-... directly on actuator
InSwitch	2 external aux. switches, adjustable
HV-S...	Comfortable manual override for...Max actuators size S
KB-S	Clamp for damper shafts \varnothing 10...20 mm and \square 10...16 mm
AR-12-xx	Reduction part for 12 mm square connection to 11, 10, 9 or 8 mm shafts
Kit-S8	Cable glands nickel-plated
Adaptions	for dampers and valves on request

Electrical connection

All actuators are equipped with a universal supply unit working at a voltage range from 24...240 VAC/DC. The supply unit is self adjusting to the connected voltage!
The safety operation of the spring return function works if the supply voltage is cut.

For electrical connection a terminal box is required (e.g. InBox).
An over-current protection fuse < 10 A has to be provided by installer.
Note: the initial current is appr. 2 A for 1 second.

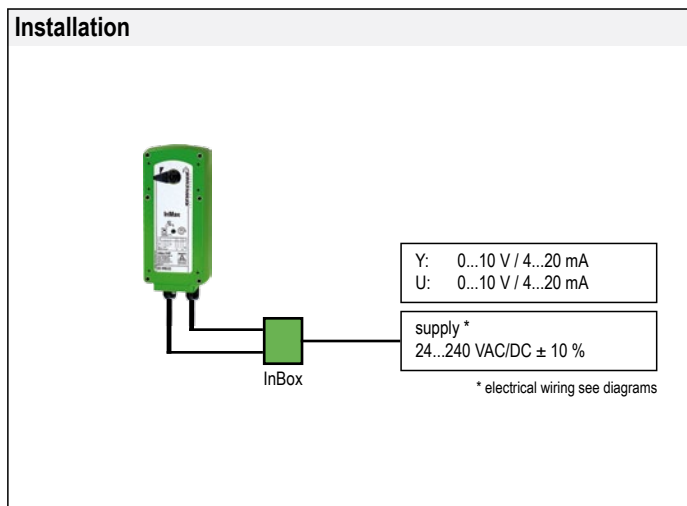
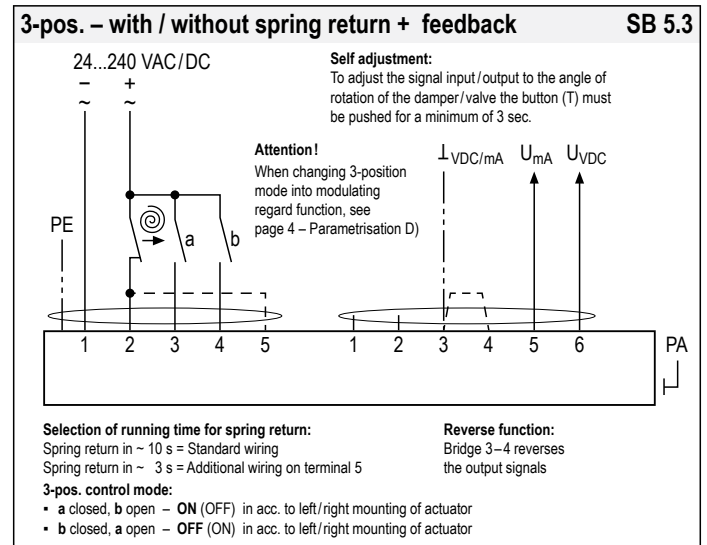
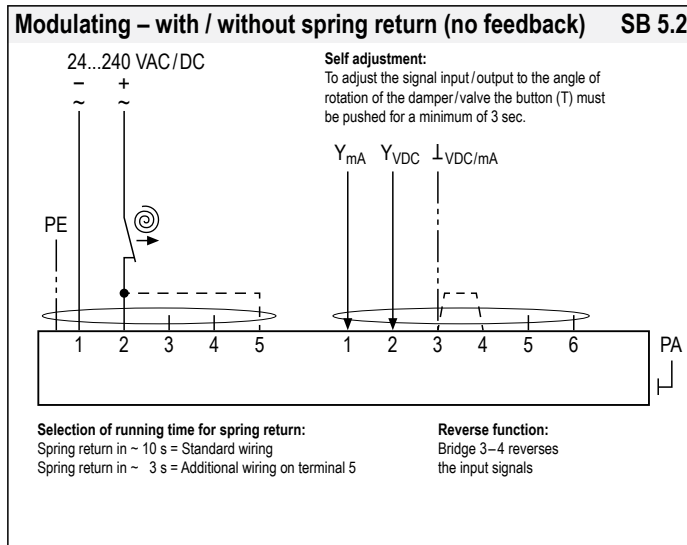
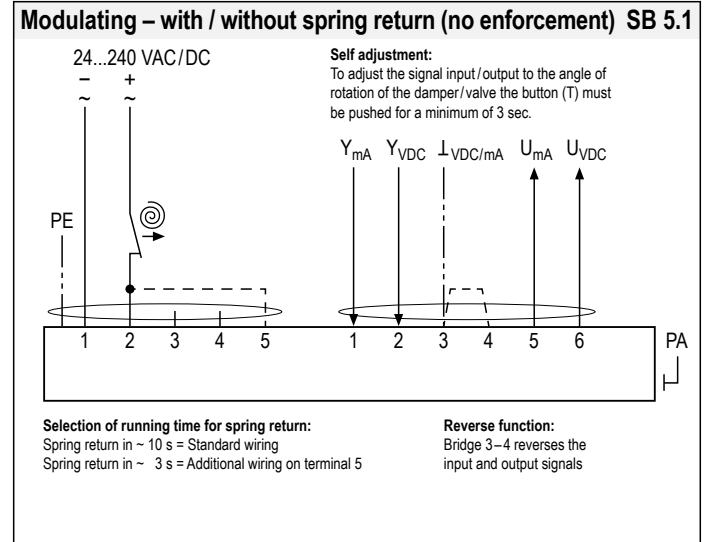
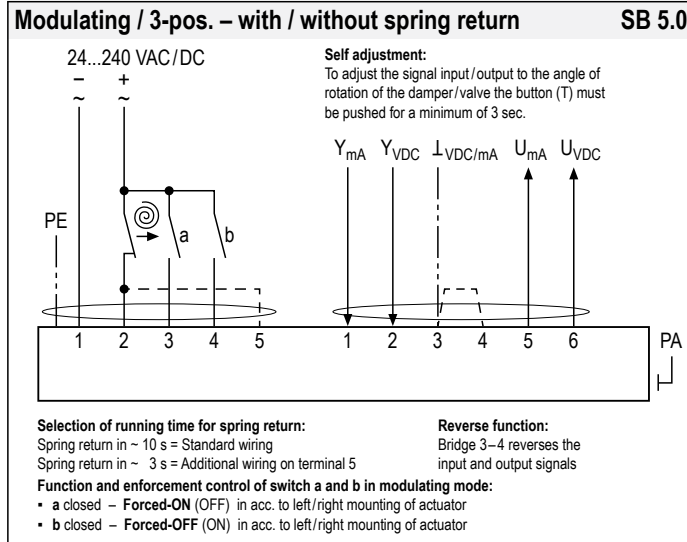

Important information for installation and operation

A. Installation, commissioning, maintenance

All national and international standards, rules and regulations must be complied with. Apparatus must be installed in accordance with manufacturer instructions. If the equipment is used in a manner not specified by the manufacturer, the safety protection provided by the equipment may be impaired.

For electrical connection a terminal box is requested (e.g. InBox-...).

Attention: If the actuator is put out of operation all rules and regulations must be applied. You have to cut the supply voltage before opening a terminal box!

The cable of the actuator must be installed in a fixed position and protected against mechanical and thermal damage. Connect potential earth. Avoid temperature transfer from armature to actuator! Close all openings with min. IP66. For outdoor installation a protective housing against sun, rain and snow should be applied to the actuator as well as a constant supply at terminal 1 and 2 for the integrated heater. During commissioning apply a self adjustment drive.

Actuators are maintenance free. An annual inspection is recommended. Actuators must not be opened by the customer.

continue next page

Important information for installation and operation

B. Manual override

Manual override only if supply voltage is cut. Use delivered socket wrench with slow motions, usage can be tight. **Attention:** Releasing or letting go the Allen key too fast at manual operating actuators with spring return causes risk of injury!

C. Shaft connection, selection of running time

Actuators are equipped with a direct coupling double square shaft connection of 12 × 12 mm. For round shafts adaptors/clamping connection (accessories, e.g. KB-S) are available. The housing of the actuator is axially symmetrically built to select Open-close direction of the spring return function by left-right mounting. Using the 10-position switch different motor running times and spring return running times can be selected on site in acc. to the actuator type.

D. 3-position control mode

...Max actuators are in the best way suitable for the 3-pos. operation. To protect such elements as gears and mounting elements against harmful influences like minimum pulse time, ...Max actuators are protected via internal electronics. It ignores impulses < 0.5 s, the cyclic duration must be min. 0.5 s. At changing direction the pause is 1 s.

E. Spring return

Spring return function works only if the supply voltage for terminal 1 or 2 is cut. In the event of an electrical interruption, the spring returns to its end position even if supply voltage is available again during return function. Thereafter operation will continue.

F. Operation at ambient temperatures below -20 °C

All actuators are equipped with a regulated integrated heating device designed for employments down to -40 °C ambient temperature. The heater will be supplied automatically by connecting the constant voltage supply on the clamps 1 and 2.

1. After mounting the actuator must be immediately electrically connected.
2. The heater switches on automatically when actuator reaches internally -20 °C. It heats up the actuator to a proper working temperature, then heater switches off automatically. Actuator will not run during heating process.
3. The adjustment options are only ensured after this heating up period.

G. Excess temperatures

All actuators are protected against excess temperature. The internal thermostat works as a maximum limiter and, in the event of failure at incorrect temperatures, shuts off the actuator irreversibly. An upstream connected temperature sensor stops the actuator before reaching its max. temperature. This safety feature is reversible, after cooling down the actuator is completely functional again. In this case the failure must be eliminated immediately on site!

H. Synchron mode

Do not connect several actuators to one shaft or link mechanically together.

I. Mechanical protection

Actuators must be operated with a minimum external load. After installing the actuator to the damper/armature a self adjustment drive has to be performed in order to protect the damper/armature against mechanical overload. During operation the actuator reduces briefly its speed (motor power) before reaching the end position for a "gentle" blockade/stop.

ⓘ Extra information (see additional data sheet)

Additional technical information, dimensions, installation instruction, illustration and failure indication

Parameters, adjustments and failure indication

Switch – Push button – Lamp for adjustment (behind the blanking plug)

10-position switch (S)

Push button (T)

3-colour LED

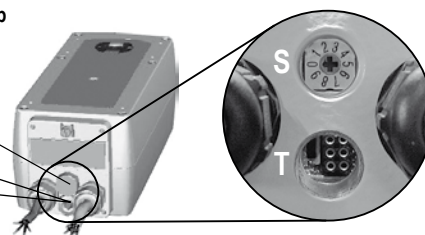

Parameter selection

Example:
InMax-15.30-Y

Requested parameter:
Torque 30 Nm
Motor running time 30 s/90°

Result:
Switch position **07**

Type	Torques	
InMax- 5.10-Y ▶	5 Nm	10 Nm
InMax- 15.30-Y ▶	15 Nm	30 Nm
InMax- 5.10-YF ▶	5 Nm	10 Nm
InMax- 15-YF ▶	15 Nm	
	▼	▼
Running times	Position of switch S	
7,5 s/90° ▶	00	05
15 s/90° ▶	01	06
30 s/90° ▶	02	07
60 s/90° ▶	03	08
120 s/90° ▶	04	09

Functions, adjustments and parameters

A) Self adjustment of angle of rotation

Turn switch (S) to position 02 (low torque) or 07 (high torque). Press button (T) for a minimum of 3 seconds. The actuator drives to both end positions and detects the blocking positions. The LED flashes GREEN during adjustment.

The adjustment takes about 60 seconds (30 sec. "On", 30 sec. "Off").

B) Selecting motor running time and torque

Adjust parameters only if actuator is in idle state or without applied potential.

Turn switch (S) to the position required for the intended operation acc. to table above. The selected parameters will be carried out at the actuator's next operation.

C) Selecting spring return time

Spring return time is selected by wiring.

D) Changing modulating operation to 3-pos. operation with feedback

Modulating mode: The LED lights GREEN, potential applied.

Press button (T) briefly 3 times:

- each for at least 0.2 seconds
- altogether within max. 5 seconds

The LED changes from steady GREEN to steady YELLOW*.

E) Changing 3-pos. operation with feedback to modulating operation

3-pos. mode: The LED lights YELLOW*, potential applied.

Press button (T) briefly 3 times.

The LED changes from steady YELLOW* to steady GREEN.

F) Additional information for control in 3-pos. operation with feedback

a closed, b open = direction I a and b closed = motor doesn't work
b closed, a open = direction II a and b open = motor doesn't work

The rotation direction (I and II) depends on left/right mounting of the actuator to the damper. To reverse the rotation direction (by motor) exchange the electrical wiring of terminal 3 and 4.

In 3-pos. operation with feedback the Y-inputs are without function.

G) Inverting <=> Reverting

Bridging signal wires 3–4 (cable B) inverts the function of input signals Y and feedback signals U.

* Note: "YELLOW" may vary from yellowish to orange.



During commissioning apply a self adjustment drive.
Regard duty cycle at motor running times!
Never use spring return actuators without external load.